

Upcycled Street Furniture

Aryan Sahai

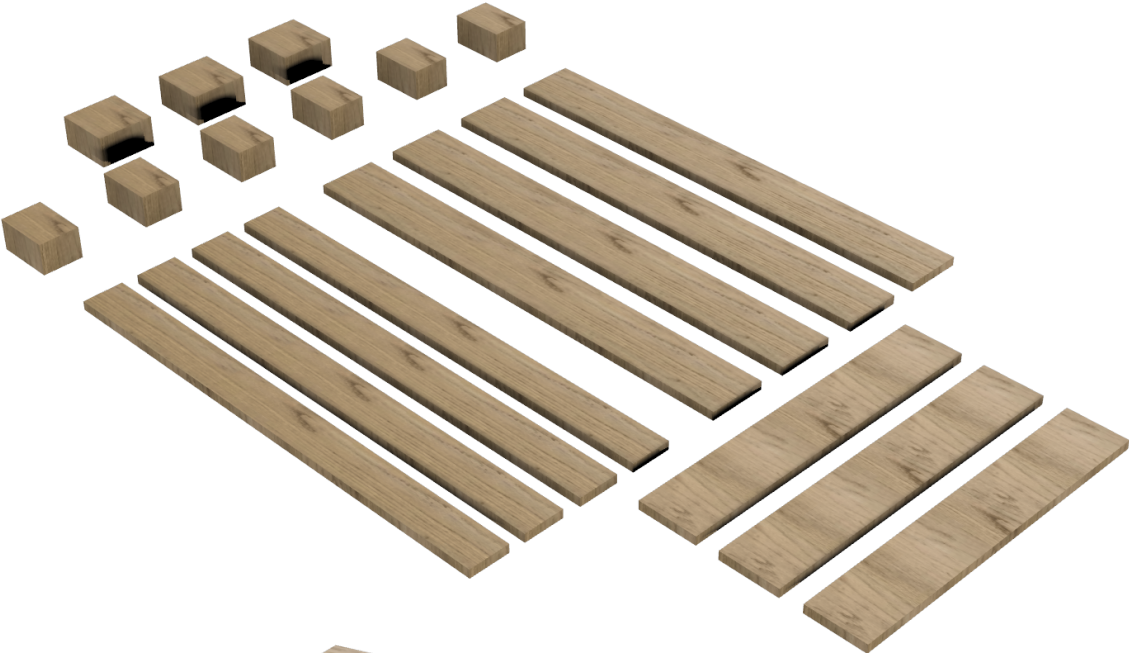

EURO Pallet Parts



Ideas

I will design a **plant holder/stand** that can be used in **households** and **parks** to **promote greenery** and the need to **protect** our **environment**.

Design 1

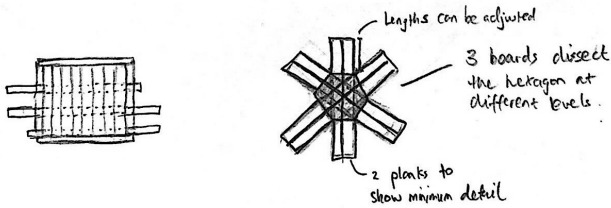
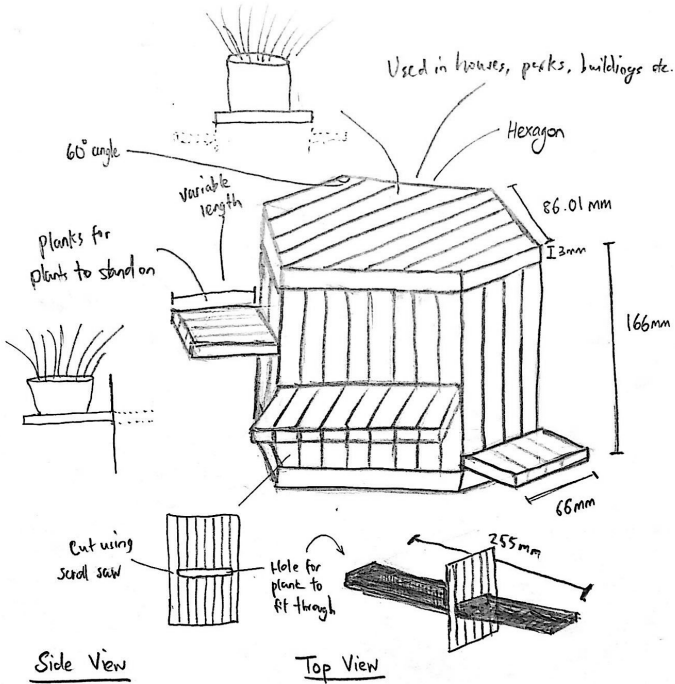

Design 2

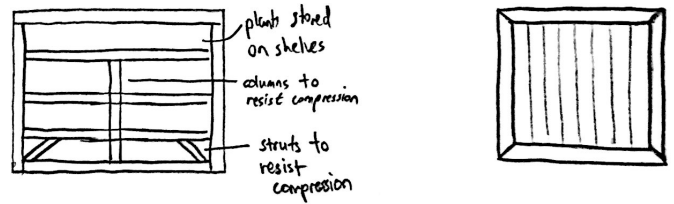
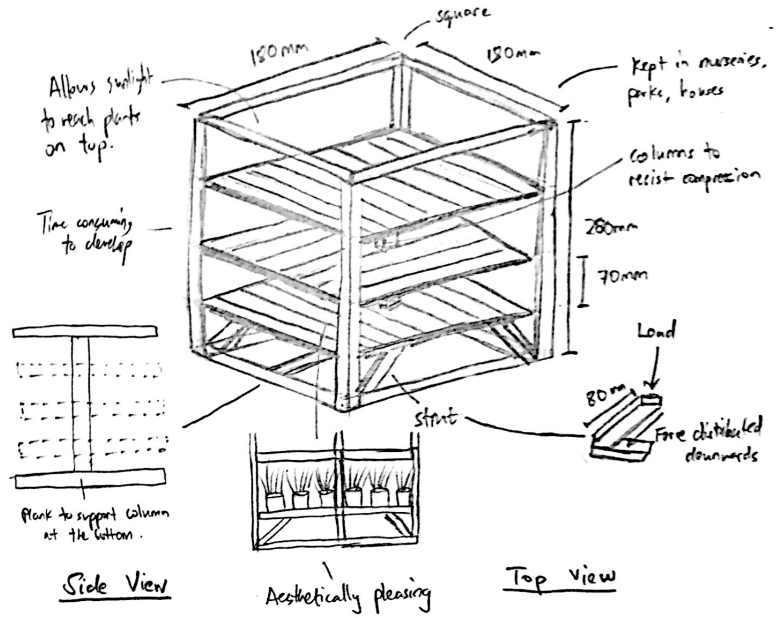

Design 3

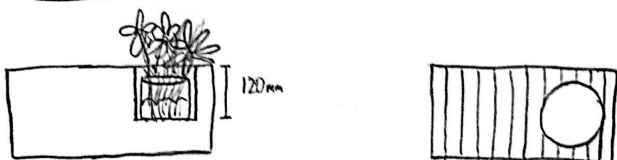
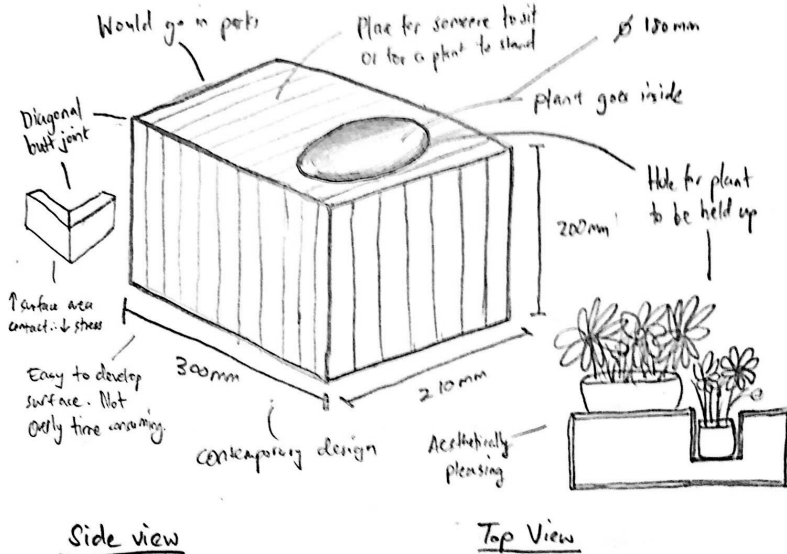

Design 4

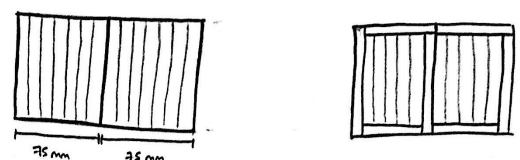
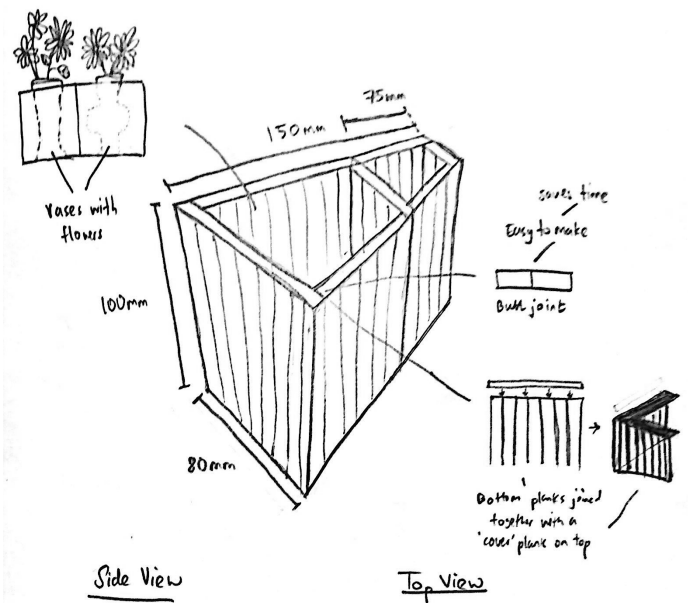

Ideas

Design 5

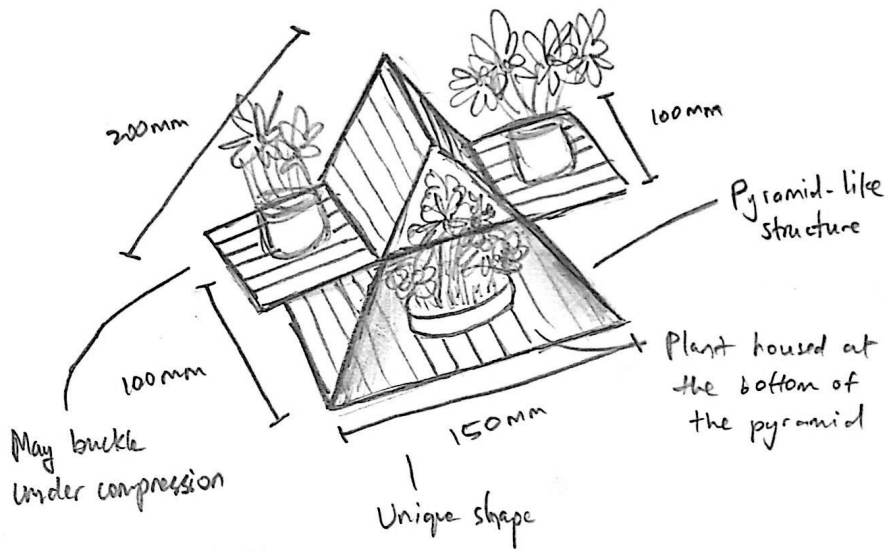

Side View

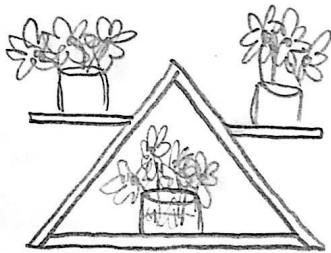

Top View

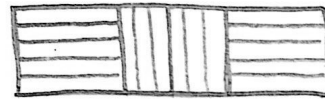

Design 6

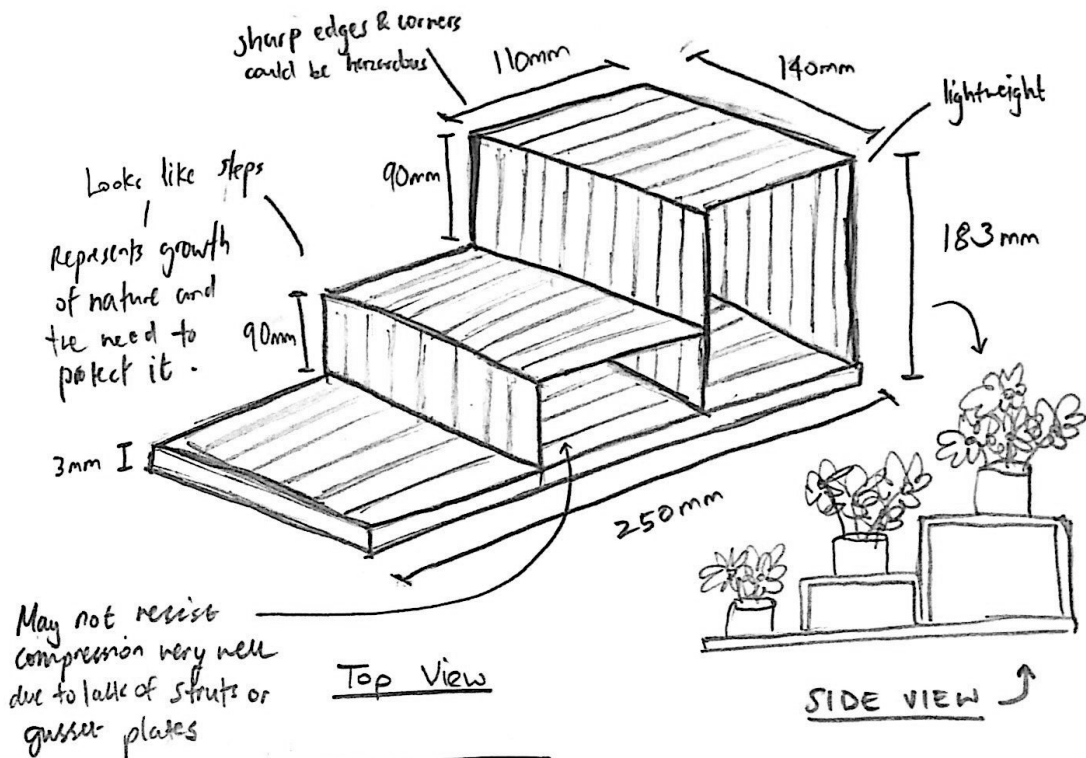

Top View

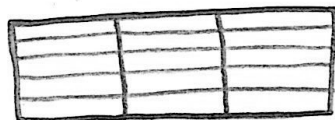

SIDE VIEW

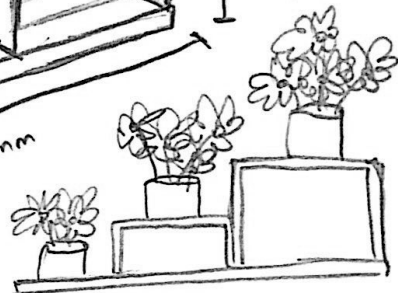

Proposed Idea

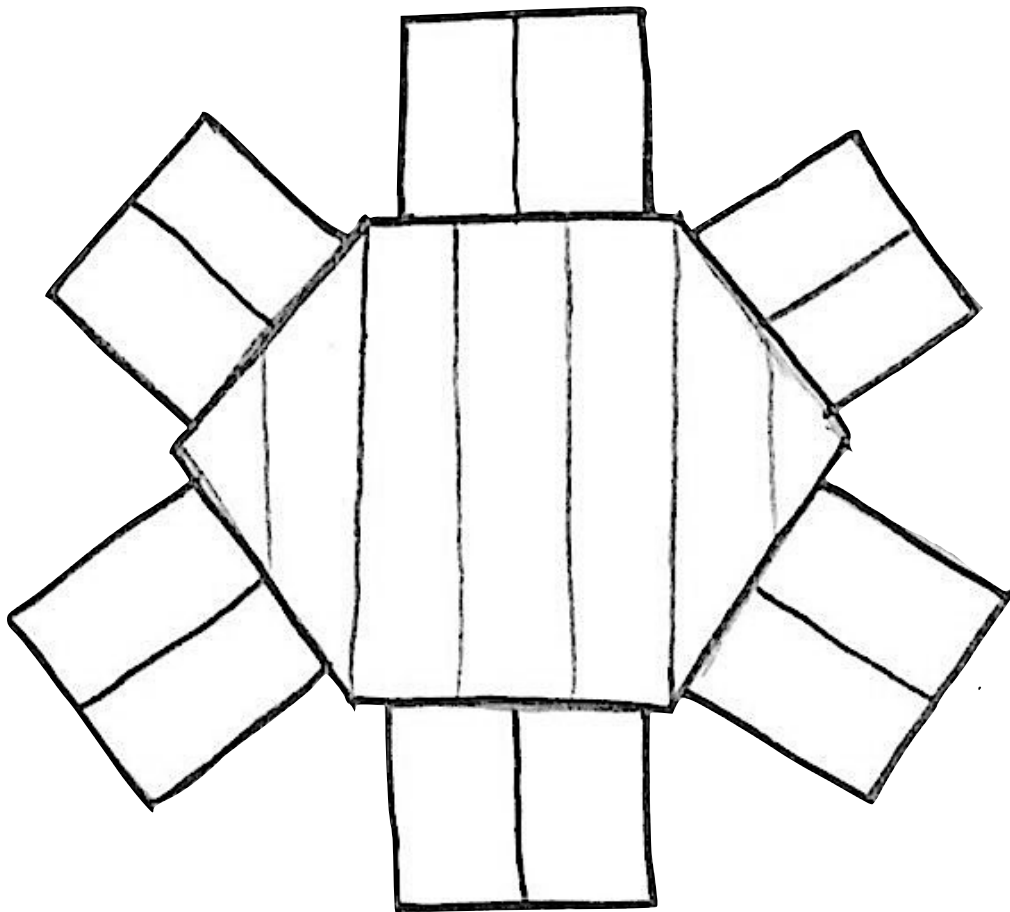
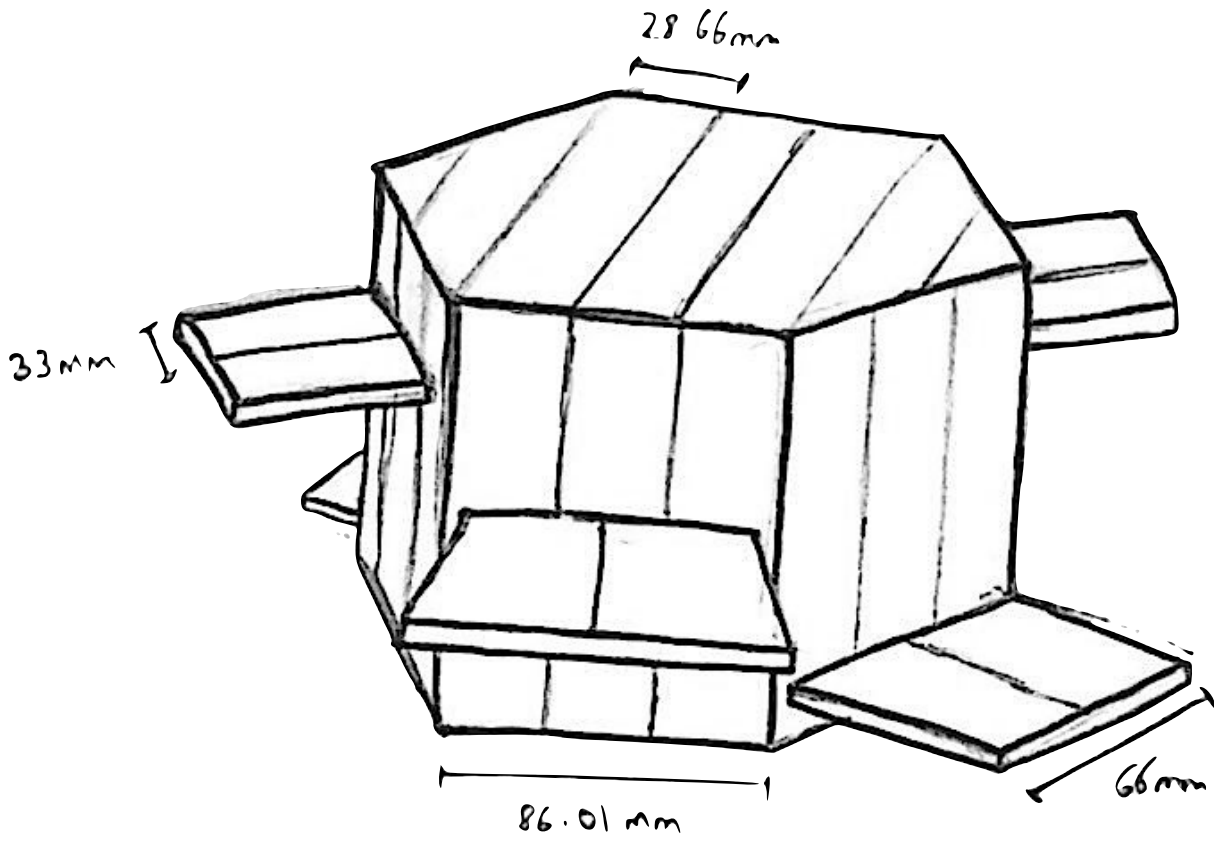

Proposed Size of Components

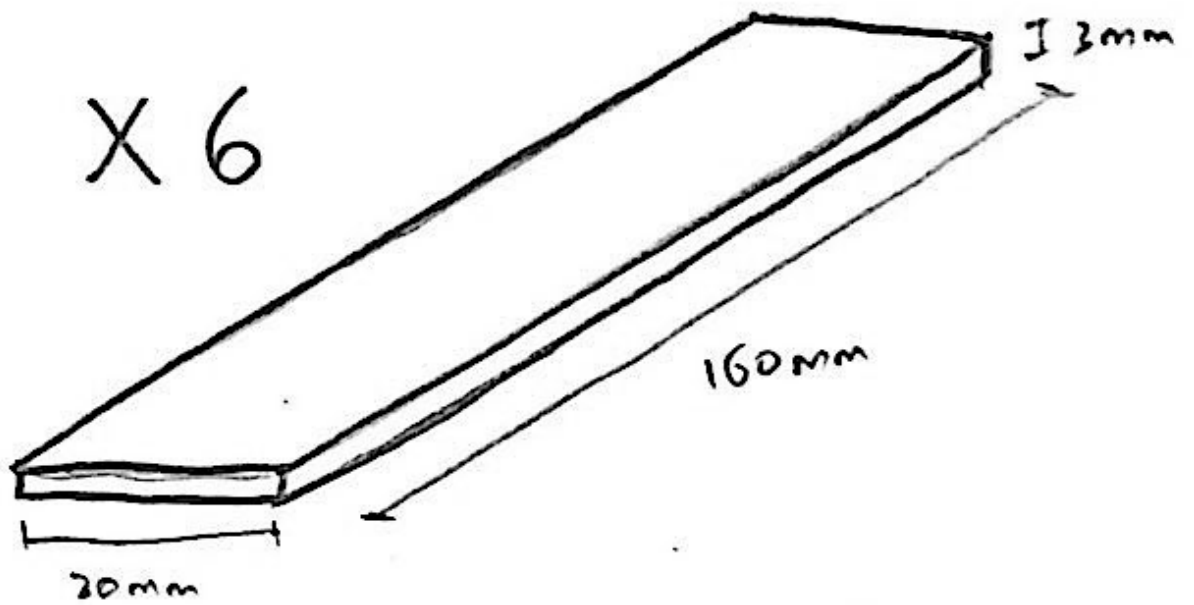
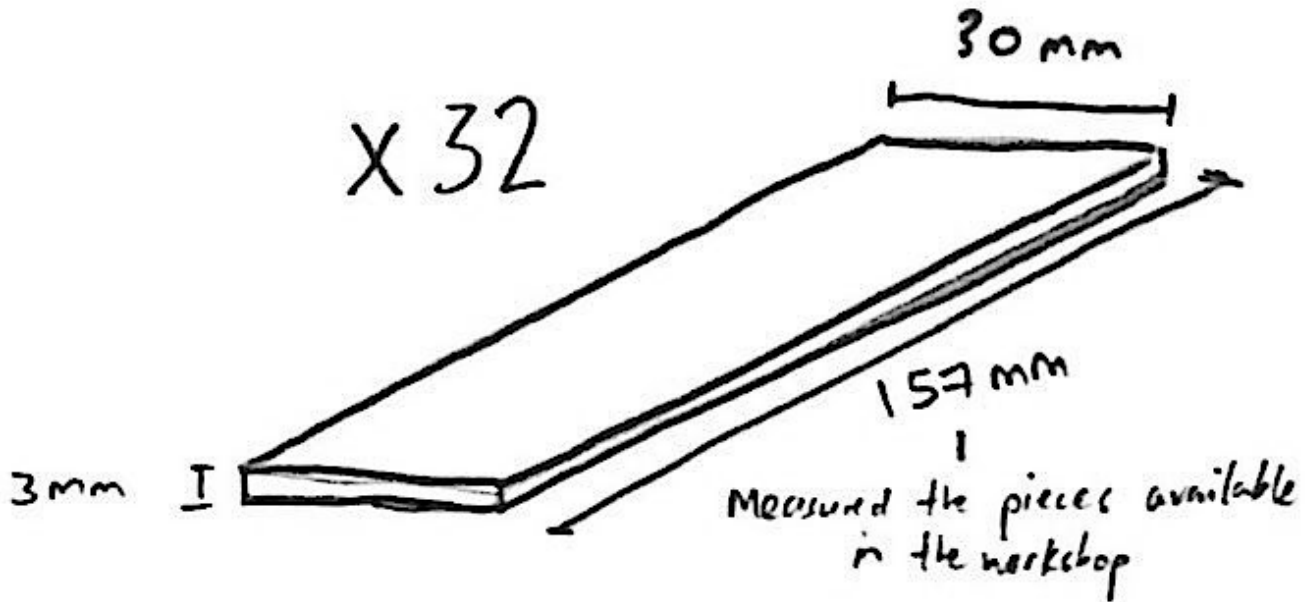

Physical Prototype

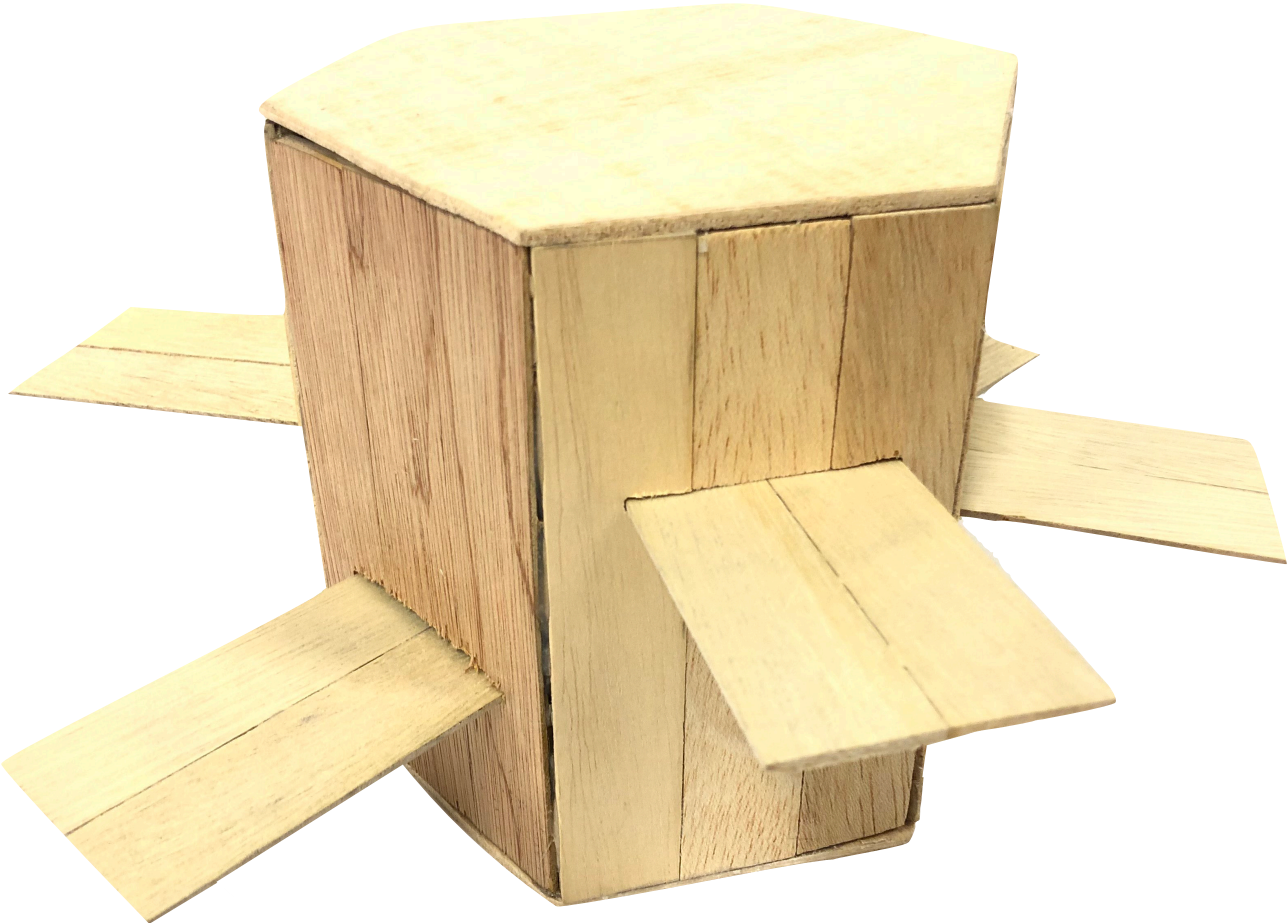

Physical Prototype

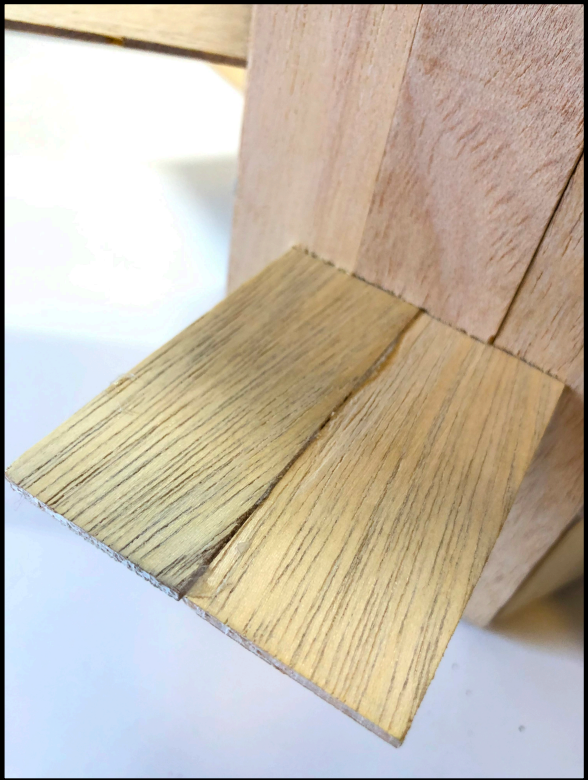
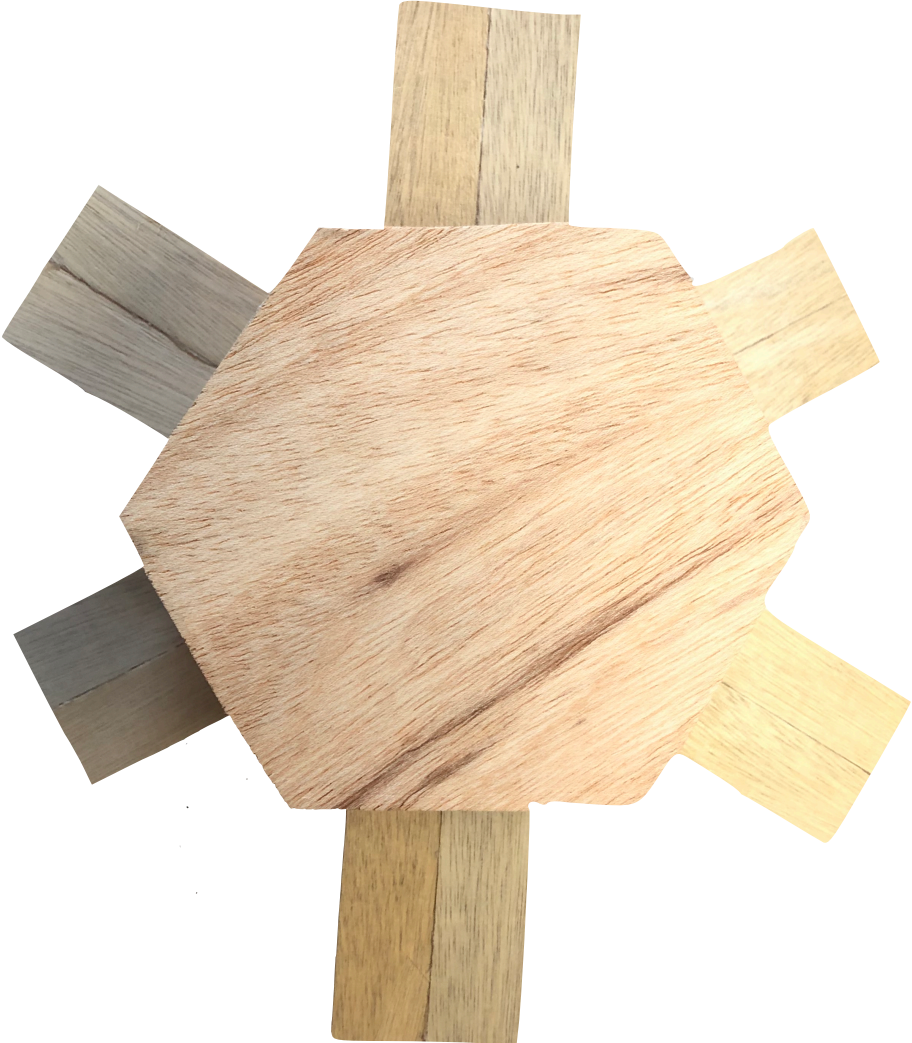

CAD

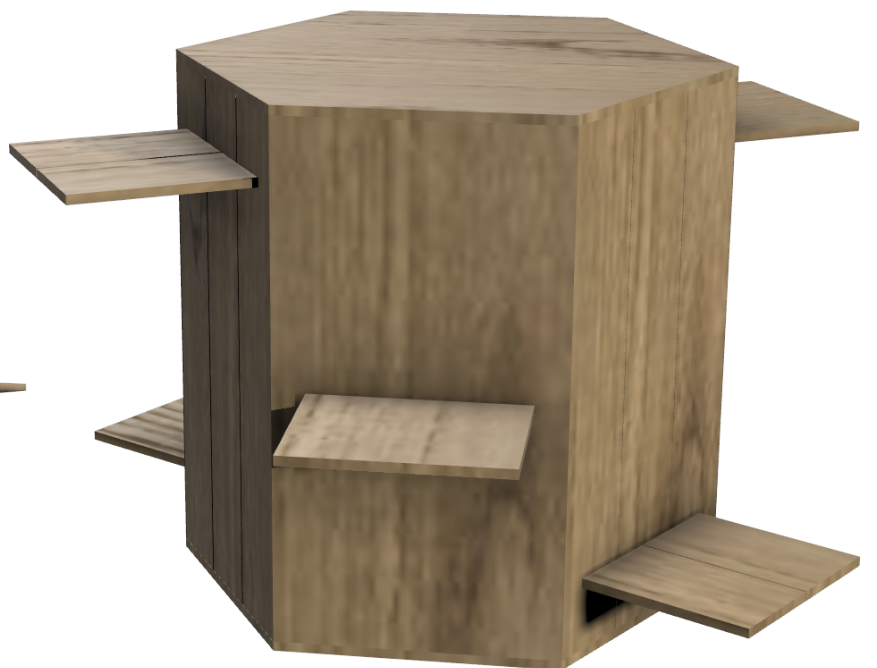
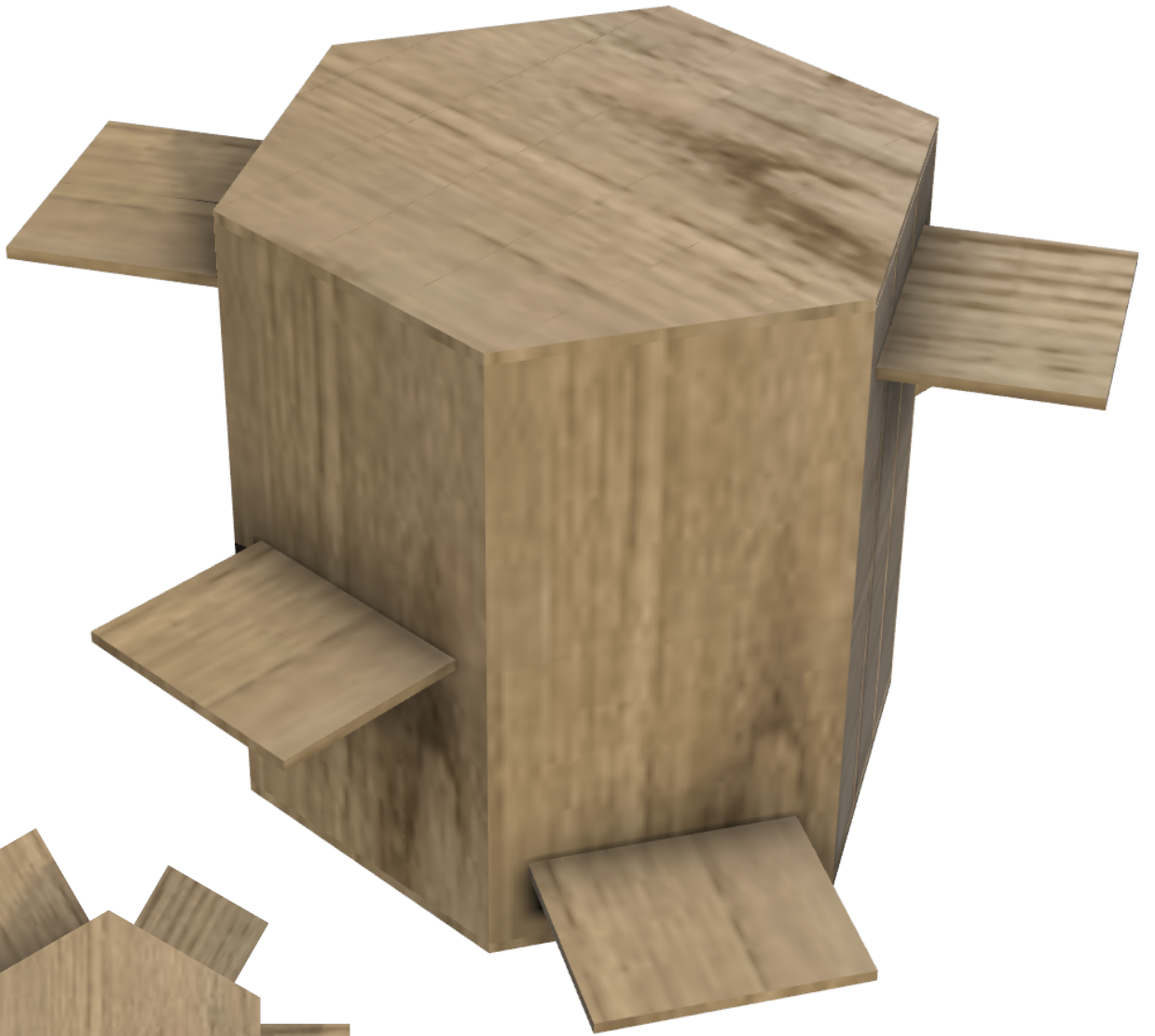

CAD Orthographic

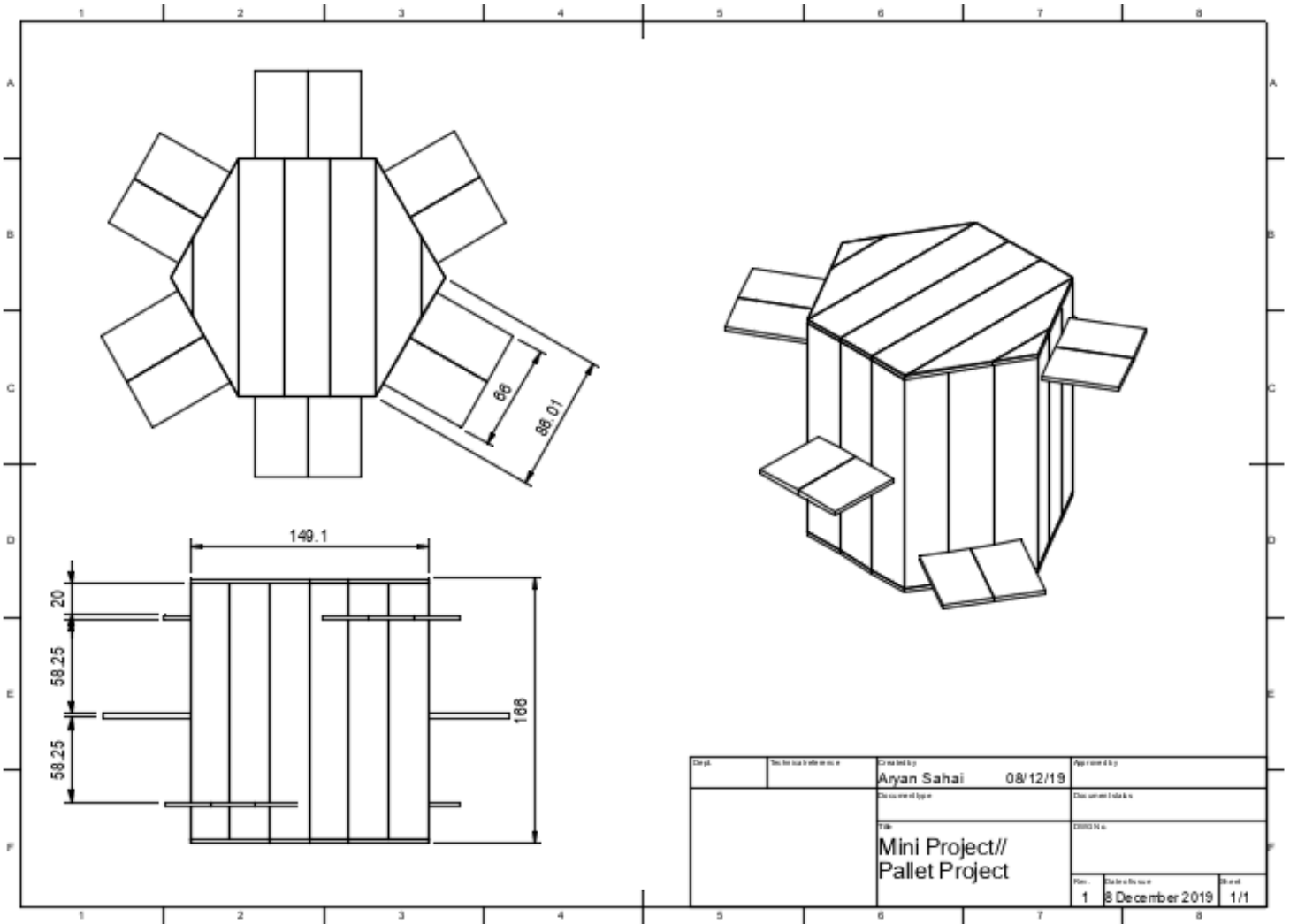

Exploded Isometric

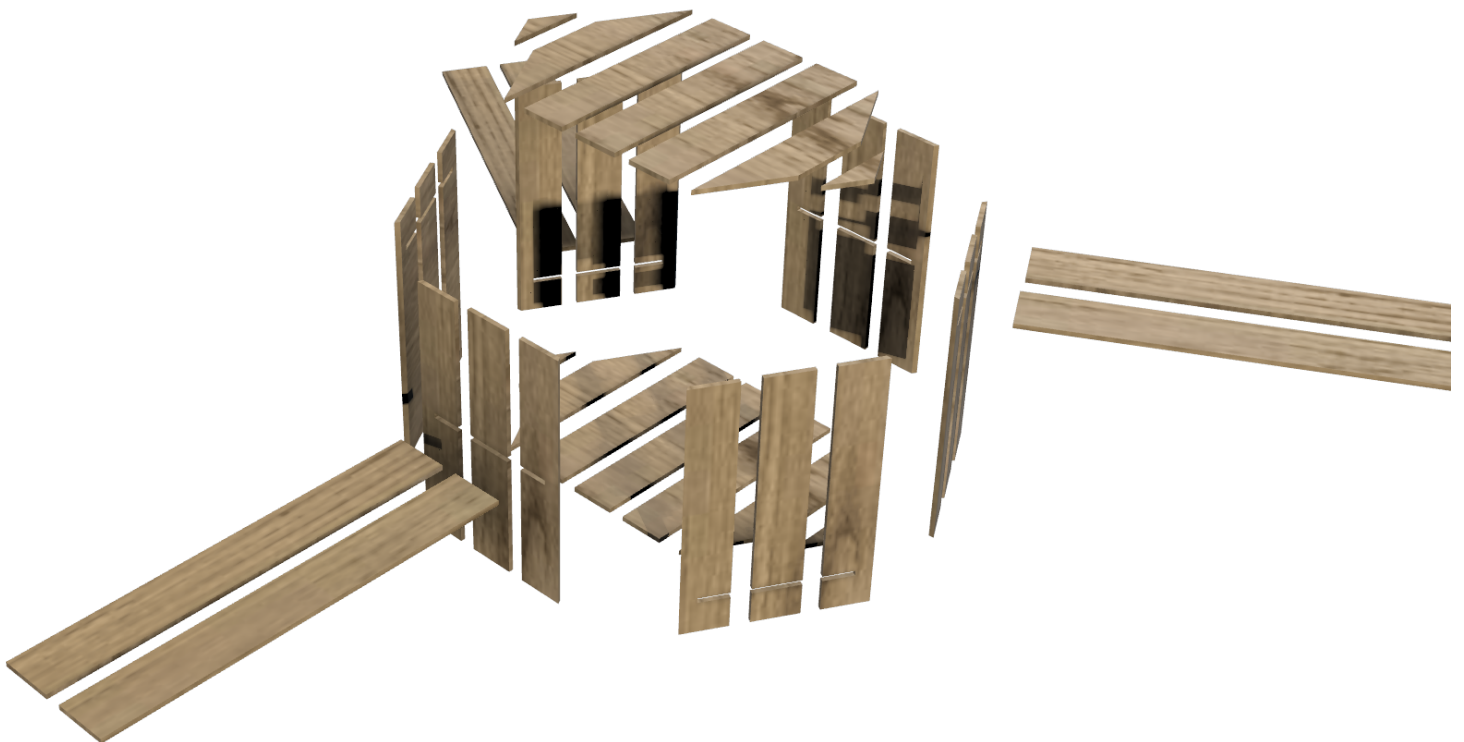

Bill of Materials

Item	Description	Dimensions	Materials	Quantity
1	Cover Boards	149.1(max)x28.69x3mm	Plywood	7
2	Flooring Boards	149.1(max)x28.69x3mm	Plywood	7
3	Outer Boards	160x28.66x3mm	Plywood	18
4	Linking Boards	255x33x3mm	Plywood	6

Product in Environment

